

DJI FORCE PRO

User Guide

使用说明

v1.0

2019.04

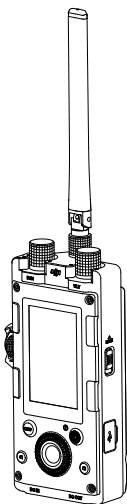

Disclaimer and Warning

Congratulations on purchasing your new DJI OSMO™ product. The information in this document affects your safety and your legal rights and responsibilities. Read this entire document carefully to ensure proper configuration before use. Failure to read and follow instructions and warnings in this document may result in serious injury to yourself or others, damage to your DJI OSMO product, or damage to other objects in the vicinity. This document and all other collateral documents are subject to change at the sole discretion of DJI OSMO.

By using this product, you hereby signify that you have read this disclaimer and warning carefully and that you understand and agree to abide by the terms and conditions herein. You agree that you are solely responsible for your own conduct while using this product, and for any consequences thereof. You agree to use this product only for purposes that are proper and in accordance with all applicable laws, rules, and regulations, and all terms, precautions, practices, policies and guidelines DJI OSMO has made and may make available.

DJI OSMO accepts no liability for damage, injury or any legal responsibility incurred directly or indirectly from the use of this product. The user shall observe safe and lawful practices including, but not limited to, those set forth in this document.

Notwithstanding above, your statutory rights under applicable national legislation are not affected by this disclaimer.

OSMO is a trademark of SZ DJI OSMO TECHNOLOGY CO., LTD. (abbreviated as "DJI OSMO") and its affiliated companies. Names of products, brands, etc., appearing in this document are trademarks or registered trademarks of their respective owner companies. This product and document are copyrighted by DJI OSMO with all rights reserved. No part of this product or document shall be reproduced in any form without prior written consent of or authorization from DJI OSMO.

In the Box

Force Pro ×1



Inspire 2 RC CAN Bus Cable (5 m) ×1



Wireless Receiver CAN Bus Cable (0.8 m) ×1



USB-C Cable ×1



Screw ×2



L-Bracket ×1



Storage Case ×1



Manuals

- DJI Force Pro User Guide
- DJI Pro Wireless Receiver User Guide

DJI Pro Wireless Receiver* ×1



UART to D-Bus Cable* ×1



S-Bus Cable* ×1



Antenna* ×4



* Items are included in the DJI Pro Wireless Receiver's package.



- DO NOT mix up the Inspire 2 RC CAN Bus cable and Wireless Receiver CAN Bus cable, otherwise it may damage the device.
- The storage case can be placed in the Ronin 2 's Water Tight Protective Case.

Introduction

Employing industry-leading communication technologies and control algorithms, the DJI Force Pro is a camera movement control system that allows operators to control gimbals remotely with high accuracy. By precisely synchronizing operator movement with camera movement, the Force Pro allows operators to masterfully capture complicated shots more intuitively than ever.

Used with the DJI wireless receiver, Force Pro's dual-frequency 2.4 GHz and 5.8 GHz wireless transmission system delivers a control distance of up to 3 km (unobstructed and free of interference). It also supports a wired connection, which eliminates interference with other equipment on a film set.

The screen and dedicated buttons make it easy to set up parameters on the Force Pro and gimbal. Featuring a 4730 mAh battery that offers up to 5 hours of continuous operation, the Force Pro has enough power for an entire shoot.

The Force Pro is currently compatible with RONIN™ 2 and Ronin-S, with support for more devices coming soon. It can be mounted on a tripod or used handheld with the adapter.

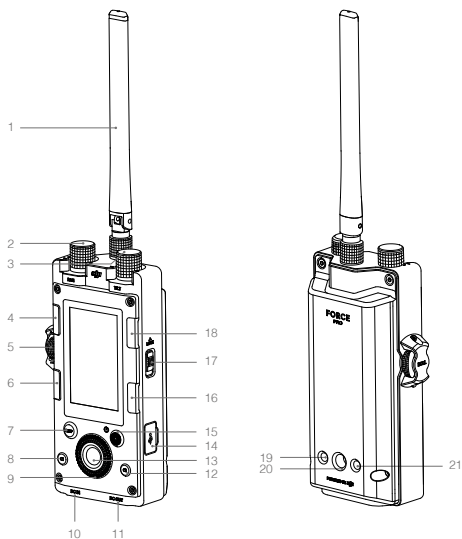

1. **Antenna**
Relays control signals. Do not obstruct the antenna.
2. **Pan Axis Speed Control Knob**
Turn this to adjust the maximum speed of the pan axis. Set the value to 65 for a 1:1 movement ratio between the gimbal and Force Pro.
3. **Tilt Axis Speed Control Knob**
Turn this to adjust the maximum speed of the tilt axis. Set the value to 65 for a 1:1 movement ratio between the gimbal and Force Pro.
4. **Mounting Mode**
Press this button to select a gimbal mounting mode.
5. **Roll Axis Speed Control Knob**
Turn this to adjust the maximum speed of the roll axis. Set the value to 65 for a 1:1 movement ratio between the gimbal and Force Pro.
6. **Back Button**
Press once to return to the previous menu.
7. **Sleep Button**
Press and hold the button to enable and disable gimbal sleep mode. The Force Pro is unable to control the gimbal while in sleep mode.
8. **C1 Button**
Customizable button.
9. **Jog Wheel**
Rotate to select options.
10. **DC IN Port**
Supports 9-26 V DC input with communication functionality. The DJI Force Pro can be powered by other power source through this port.
11. **DC OUT Port**
Supports 5 V DC output with communication functionality.
12. **C2 Button**
Customizable button.
13. **OK Button**
Press once to confirm an option.
14. **USB-C Port**
For charging and updating the firmware of the Force Pro.
15. **Power/Record Button**
Press to turn on/off the Force Pro (press and hold for eight seconds to turn it off mandatorily). Press once to check the battery level when powered off. Press once to start/stop recording video when powered on.
16. **Toggle Button**
Press once to toggle between the submenus.
17. **Lock Button**
Lock the Force Pro to avoid accidental operation.
18. **Follow Mode Button**
Selects Follow mode.
19. **Mounting Hole 1**
1/4"-20 thread with a 10 mm depth.
20. **Mounting Hole 2**
3/8"-16 thread with a 10 mm depth.
21. **Mounting Hole 3**
1/4"-20 thread with a 10 mm depth.

Installation

Attach the antenna to the Force Pro and then tighten the securing knob.

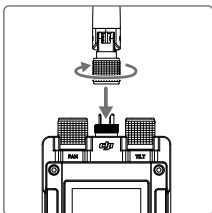

The Force Pro can be used handheld or mounted on a tripod with the provided adapter. First, attach the adapter using the provided screws and tighten.

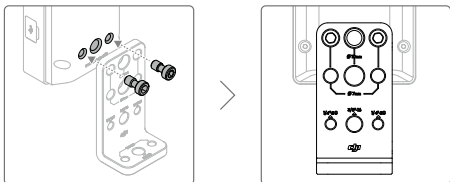

Then attach the Force Pro to the handle as shown. A Ronin 2 monitor adapter (sold separately) is needed during installation.

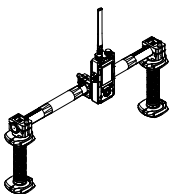

Mounting the DJI Force Pro on a tripod.

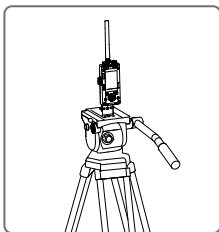

Keep the DJI Force Pro and its antenna vertical during usage to obtain the optimal performance.

The Force Pro must be used with a DJI Pro wireless receiver, please refer to the DJI Pro Wireless Receiver User Guide for details.

Activation

Press and hold the power button to turn on the Force Pro. Activation is required when using it for the first time.

Download the DJI Pro Assistant for Ronin software, and then connect the Force Pro to your computer. Launch DJI Pro Assistant for Ronin and follow the on-screen instructions to activate your Force Pro.

Linking

The Force Pro supports both wireless and wired connections. Linking is required when using a wireless connection:

1. Go to the gimbal settings page on the Force Pro and go to "Settings-> General-> Linking;"
2. Press and hold the link button on the DJI Pro Wireless Receiver for two seconds to initiate the linking procedure.

Using the DJI Pro Wireless Receiver is recommended for optimal performance.

You can also connect a Force Pro to Ronin 2 using Ronin 2's linking procedures.

For the wired connection, connect the DC OUT port on the Force Pro to Ronin 2 using Ronin 2 CAN Bus Control Cable (30 m, sold separately).

Settings

These settings are based on using the Force Pro with Ronin 2.

Main UI Settings

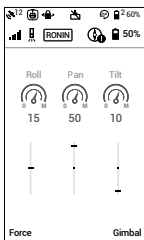

1. GPS Signal Strength

¹²: Shows the current GPS signal strength.

2. Mounting Modes (If supported)

: Handheld mode.

: Car Mount mode.

: Aerial mode.

: Tripod mode.

3. Pan Lock Mode

: Pan motor follow off.

4. Motor Pause

: Powers off motors.

5. Follow Mode

: Free mode.

: Follow mode.

: FPV mode.

: Recenter mode.

Select Free mode when using the Force Pro.

6. Working Battery Number

²: Shows the number of batteries currently in use by Ronin 2. Ronin 2 can operate with one or two batteries.

7. Battery Level

60%: Displays the current battery level of Ronin 2.

8. Remote Controller Signal Strength

: Displays the remote controller signal strength.

9. Calibration Notice

: Compass calibration is required.

10. Force Pro Battery Level

50%: Displays the current battery level of the Force Pro.

11. Axes Control Speed Display

Displays the control speed for the three axes.

Force Pro Settings

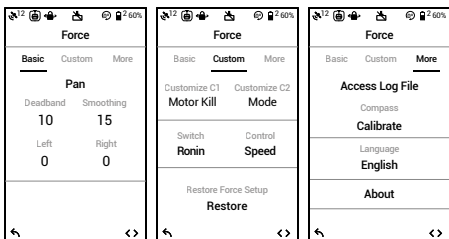

Basic

The Deadband, Smoothing, and Endpoints settings for the pan, roll, and tilt axes can be independently adjusted. The default endpoint settings for pan axis are set to 180°, which means there is no endpoint for the pan axis, allowing it to rotate 360° continuously.

Custom

Customized functions for the C1 and C2 buttons: Includes Pause, Recenter, Ronin 2 Pause, and Control mode options.

Control Mode: Includes Speed and Position Control modes.

In Speed mode, turn the Speed Control knob to adjust the movement ratio between the gimbal and Force Pro. Increase the Smoothing to make the gimbal's translated movement smoother and slower. Adjust the Deadband to adjust the gimbal's response sensitivity.

In Position mode, the movement ratio between the gimbal and Force Pro remains 1:1. Turn the Speed Control knob to adjust the gimbal's response sensitivity. In Position mode, the Speed Control knob is the only factor that will affect the gimbal movement.

Restore force setup: Restores the Force Pro to its default settings.

More

Access log file: Internal storage is built into the Force Pro for recording data. If the gimbal is acting abnormally, contact DJI Support. If the provided solutions are not successful, DJI Support will request log files for further analysis. Access log files only when instructed to do so by a DJI support specialist.

Compass Calibration: If errors occur with the compass, select "Calibrate" and then follow the onscreen instructions to calibrate the compass.

Language: Languages can be switched between English and Chinese.

About: Displays the SN number and the firmware version of your Force Pro.

Gimbal Settings

Motor

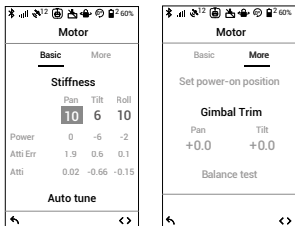

Basic: The Auto tune, Stiffness, Strength, Filter, and Control values for the tilt, roll, and pan axes can be set independently. Refer to the Ronin 2 user manual for details.

More: Set power-on position, fine tune the pan or tilt axis, and test the balance for three axes.

SmoothTrack

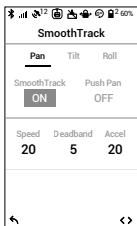

Settings for the pan, roll, and tilt axes can be set independently.

Monitor

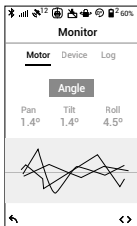

Motor: Displays the power, angle, and temperature of the motors.

Device: Displays the connection status with other devices.

Log: Displays any abnormal status information of the gimbal.

System Settings

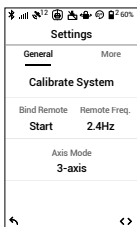

General: Includes the Calibrate System, Binding, operating Wi-Fi frequencies, and gimbal working modes.

Profile: Custom motor configurations can be saved or reset to default settings.

Camera Page

Control camera recording and various other supported settings when a camera control cable is attached.

Charging

Use the provided USB-C cable to charge the Force Pro using a USB charger (not provided).

Connect the DC IN port during usage to power the Force Pro. Connect the DC OUT port to use the Force Pro to power the connected device.

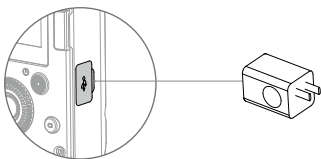

Charging time: \approx 2 hours
(when charging at 2 A with the Force Pro powered off)

Updating Firmware

Connect the USB-C port on the Force Pro and the DJI Pro Assistant for Ronin and follow the onscreen instructions to update the firmware.

Specifications

Power Consumption	3 W
Voltage	3.85 V
Battery Capacity/Energy	4730 mAh/18.21 Wh
Operating Temperature	-4° to 104° F (-20° to 40° C)
Charging Temperature	32° to 95° F (0° to 35° C)
Operating Time	5 hours
Charging Current	2 A
Charging Time	2 hours
DC IN	9-26 V
DC OUT	5 V/1 A



- Currently, the Force Pro can be used to control the three axes movements of the Ronin-S and set the parameters of SmoothTrack and motor. Other feature are not available.
- The Force Pro will support Inspire 2 through upcoming firmware. Check the latest Force Pro release notes for more information. DO NOT mix up the Inspire 2 RC CAN Bus cable and Wireless Receiver CAN Bus cable, otherwise it may damage the device.
- Use the Inspire 2 RC CAN Bus cable provided to connect the Force Pro and the master remote controller of Inspire 2. The DJI Pro Wireless Receiver cannot be used.

This content is subject to change.

Download the latest version from
<https://www.dji.com/force-pro>

RONIN is a trademark of DJI OSMO.
Copyright © 2019 DJI OSMO All Rights Reserved.

免责声明和警告

感谢您购买大疆灵眸™ (DJI OSMO™) 产品。本文所提及的内容关系到您的安全以及合法权益与责任。使用本产品之前, 请仔细阅读本文以确保已对产品进行正确的设置。不遵循和不按照本文的说明与警告来操作可能会给您和周围的人带来伤害, 损坏本产品或其它周围的物品。本文档及本产品所有相关的文档最终解释权归大疆灵眸 (DJI OSMO) 所有。如有更新, 恕不另行通知。请访问 www.dji.com 官方网站以获取最新的产品信息。

一旦使用本产品, 即视为您已经仔细阅读免责声明与警告, 理解、认可和接受本声明全部条款和内容。您承诺对使用本产品以及可能带来的后果负全部责任。您承诺仅出于正当目的使用本产品, 并且同意本条款以及大疆灵眸 (DJI OSMO) 制定的任何相关条例、政策和指引。

大疆灵眸 (DJI OSMO) 对于直接或间接使用本产品而造成的损坏、伤害以及任何法律责任不予负责。用户应遵循包括但不限于本文提及的所有安全指引。

即使存在上述规定, 消费者权益依然受当地法律法规所保障, 并不受本免责声明影响。

OSMO 是深圳市大疆灵眸科技有限公司及其关联公司的商标。本文出现的产品名称、品牌等, 均为其所属公司的商标或注册商标。

物品清单

体感控制器 × 1



Inspire 2 RC CAN Bus
连接线 (5 m) × 1



无线接收机 CAN Bus
连接线 (0.8 m) × 1



USB-C 数据线 × 1



螺丝 × 2



转接件 × 1



收纳盒 × 1



文档

- DJI 体感控制器专业版使用说明
- DJI 专业无线接收机使用说明

专业无线接收机 * × 1



D-Bus 转接线 * × 1



S-Bus 连接线 * × 1



天线 * × 4



* 部分物品包含在 DJI 专业无线接收机包装内。



- Inspire 2 RC CAN Bus 连接线 (5 m) 和无线接收机 CAN Bus 连接线 (0.8 m) 不可混用, 否则可能损坏设备。
- 收纳盒可放置于 Ronin 2 标配防水设备箱。

简介

DJI 体感控制器专业版 (以下简称“体感控制器”) 采用先进的通信技术, 内置指南针和高精度 IMU, 配合全新的控制算法使得云台系统能实时响应体感操作, 为专业影视拍摄提供精准直接的操控方式。

体感控制器提供有线和无线两种连接方式, 支持 2.4GHz 和 5.8GHz 双频无线通信, 配合 DJI 无线接收机, 控制距离可达 3 公里 (无干扰、无遮挡环境); 有线连接可有效避免拍摄设备间的干扰, 使得设备运行更稳定可靠。内置显示屏并配备机身按键, 方便快速调节云台以及相机参数。内置 4730 mAh 电池, 最长工作时间可达 5 小时。体感控制器目前适配 RONIN™ 2 和 Ronin-S, 可安装固定在三脚架、云台手持杆等平台。

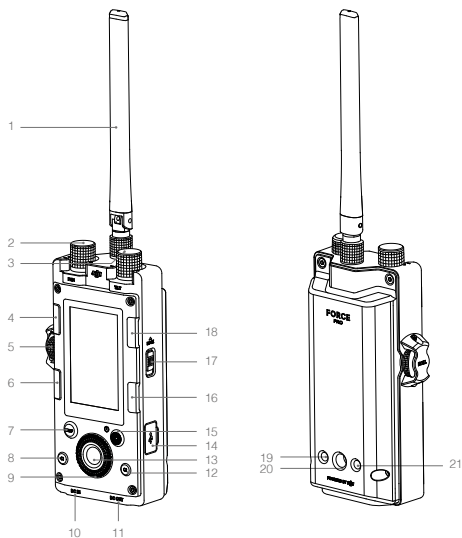

1. 天线
传输无线信号。
2. 平移轴速度控制旋钮
调节旋钮以调整体感和云台之间的速度输出比例。当使用云台体感速度为 1:1 时，体感对应设置值为 65。
3. 俯仰轴速度控制旋钮
调节旋钮以调整体感和云台之间的速度输出比例。当使用云台体感速度为 1:1 时，体感对应设置值为 65。
4. 挂载模式按键
用于选择云台挂载模式。
5. 横滚轴速度控制旋钮
调节旋钮以调整体感和云台之间的速度输出比例。当使用云台体感速度为 1:1 时，体感对应设置值为 65。
6. 返回按键
按压按键返回上一级菜单。
7. 休眠按键
长按使体感控制器进入休眠状态，此时不能控制云台，再次长按恢复。
8. C1 按键
自定义快捷按键。
9. 转盘
旋转转盘切换选项。
10. DC IN
直流输入接口，支持 9-26 V 电压输入，带通信功能。可通过此接口让外部设备给体感控制器供电。
11. DC OUT
直流输出接口，输出 5 V，带通信功能。
12. C2 按键
自定义快捷按键。
13. 确认按键
按压确认按键确定选项。
14. USB-C 接口
用于充电以及升级固件。
15. 电源 / 录影按键
长按开启或关闭体感控制器（长按 8 秒强制关机）。关机状态下，短按可查看电量；开机状态下，短按以开始 / 停止录影。
16. 切换按键
按压按键切换子页面。
17. 锁定按键
拨动按键以锁定 / 解锁体感控制器。拍摄过程中可锁定体感控制器防止误操作。
18. 跟随模式按键
用于选择不同的云台跟随模式。
19. 螺纹孔 1
1/4" -20 螺纹孔，可用深度 10 mm。
20. 螺纹孔 2
3/8" -16 螺纹孔，可用深度 10 mm。
21. 螺纹孔 3
1/4" -20 螺纹孔，可用深度 10 mm。

安装

按图示插入天线，并拧紧天线固定旋钮。

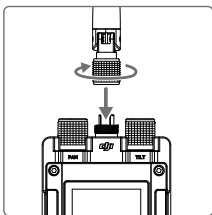

推荐安装体感控制器在云台手持横杆、三脚架等平台上使用。首先使用标配螺丝固定转接件在体感控制器上。

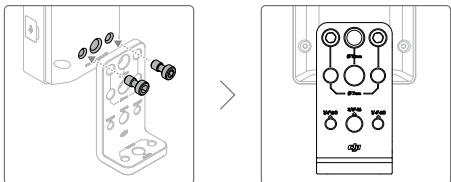

以下为安装至手持横杆示意，安装时需使用 Ronin 2 屏幕转接件（另行购买）固定体感控制器。

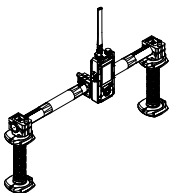

安装体感控制器至三脚架示意。

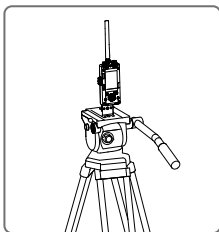

使用过程中请确保体感控制器与天线竖直以获得最佳通信信号。

体感控制器专业版需配合 DJI 专业无线接收机使用，关于接收机的详细内容，请参见包装内提供的《DJI 专业无线接收机使用说明》。

激活

长按电源按键开启体感控制器电源。首次使用时需要激活设备。

激活步骤：

下载 DJI Pro Assistant for Ronin 调参软件，使用 USB 连接线，连接体感控制器与电脑并运行 DJI Pro Assistant for Ronin，按提示激活即可。

连接云台

体感控制器支持无线连接和有线连接两种方式。若使用无线连接方式，推荐使用 DJI 专业无线接收机以获得最好的通信效果。

对频步骤：

1. 进入体感控制器云台设置界面，选择设置 > 通用 > 对频。
2. 长按接收机对频按键 2 秒或以上，进入对频。

如不使用 DJI 专业无线接收机，也可直接将体感控制器与 Ronin 2 对频（通信效果可能无法达到最佳）。

若采用有线连接方式则无需对频，使用指定的 Ronin 2 CAN Bus 控制线（30 m 长，需另行购买），连接体感控制器 DC OUT 接口至云台设备。

参数设置

以下参数设置针对体感控制器配合 Ronin 2 云台使用为例进行说明。

主界面说明

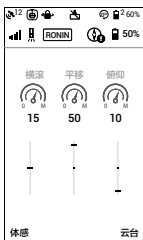

1. GPS 星数
 12：数字表示 GPS 星数。
2. 云台挂载模式
 手持模式。
 车载模式。
 飞行模式。
 三脚架模式。
3. 云台工作模式
 出现此图标，表示云台处于平移轴锁定模式。云台在平移轴锁定模式下，平移轴电机关闭，只对俯仰和横滚两轴进行增稳。
4. 电机关闭提示
 出现此图标，表示云台电机处于关闭状态。
5. 云台跟随模式
 锁定模式。
 跟随模式。
 FPV 模式。
 回中模式。
 跟体感搭配使用时，推荐选择锁定模式。
6. 工作电池数量
 2：显示云台正在工作的电池数量。
7. 云台电量
 60%：云台电池总电量百分比。
8. 遥控信号强度
 显示遥控信号强度。
9. 校准提示
 出现此图标表示体感控制器指南针需要校准。
10. 体感控制器电量
 50%：体感控制器电池电量百分比。
11. 横滚轴、平移轴、俯仰轴速度百分比
 表示当前体感三轴控制速度。

体感设置界面

按压左侧按键进入体感控制器设置界面。

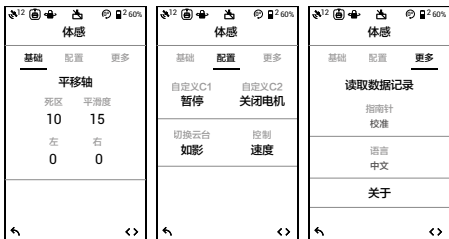

基础

可设置体感控制器控制云台平移轴、俯仰轴、横滚轴的死区、平滑度与限位。其中平移轴左右限位设置成 180° 的时候表示云台平移轴没有限位。

配置

可自定义 C1 与 C2 快捷键功能，可设置暂停、回中、关闭电机、控制模式切换。

云台挂载模式：选择云台挂载模式。

体感控制模式：体感控制模式分为速度模式和位置模式。速度模式下，通过体感速度控制旋钮可调节云台/体感转速比；改变平滑度，可以调节云台的缓起缓停；改变死区，可以调节云台对体感的响应灵敏度。

位置模式下，云台、体感的转速比保持为 1:1。通过体感速度控制旋钮可以调节云台受体感控制时候的响应灵敏度。在位置模式下，云台只受体感设置的速度参数的影响。

恢复体感参数：选择恢复至默认设置。

更多

读取数据记录：内置存储模块，可自动存储相关数据。若出现异常，请联系 DJI 售后。如有需要，售后人员将会指引用户进入“读取数据记录”并获得相关数据用于分析问题。

指南针校准：若系统提示指南针异常，则需要点击进入指南针校准。请根据提示操作。

系统语言：提供中、英两种语言选择。

关于：进入“关于”可查看设备名称、SN 码以及固件版本号。

云台设置界面

按压右侧按键进入云台设置界面。

电机



基础：平移轴、俯仰轴、横滚轴的力度、强度、滤波、超前控制值设置；显示云台电量、姿态与抖动量；进行云台自动校准。

更多：设置平移轴零位；针对平移轴与俯仰轴的云台微调；云台平衡度测试。

SmoothTrack



平移轴、俯仰轴、横滚轴的 SmoothTrack 可分别开启或关闭。平移轴、俯仰轴可开启手动调节。

监视



电机：显示平移轴、俯仰轴、横滚轴电量、关节角、温度。

设备：显示云台与外设设备连接状态。

日志：显示云台异常信息。当云台发生异常时，可进入该界面检查云台具体问题。

设置

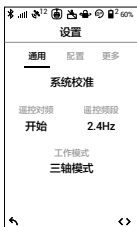

通用：进行系统校准，选择跟云台对频；设置遥控频段和云台工作模式。

配置：选择预设参数；恢复云台参数。

摄影机

在摄影机页面可控制相机录像。

充电

使用 USB-C 连接线，连接 USB-C 接口与充电器（用户自备）即可对体感控制器充电。

使用过程中，连接 DC IN 接口，可使外部设备为体感控制器供电；连接 DC OUT 接口，体感控制器可为外部设备供电。

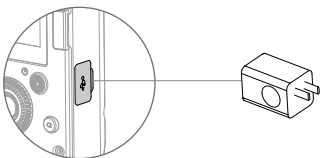

充电时间：约 2 小时
（关机状态下，充电电流为 2A 时）

升级

使用 USB 连接线，连接 USB-C 接口与 DJI Pro Assistant for Ronin 调参软件，根据提示进行升级。

规格参数

型号	
功耗	3 W
标称电压	3.85 V
电池容量 / 能量	4730 mAh/18.21 Wh
工作环境温度	-20°C 至 40°C
充电环境温度	0°C 至 35°C
工作时间	5 小时
充电电流	2 A
充电时间	2 小时
DC IN	9-26 V
DC OUT	5 V/1 A



- 使用体感控制器控制 Ronin-S 时，仅可控制云台三轴方向以及设置 SmoothTrack 和电机参数，其它功能暂不支持。
- 体感控制器后续将通过固件升级增加对 Inspire 2 的支持，具体请留意官方发布记录。Inspire 2 RC CAN Bus 连接线（5 m）和无线接收机 CAN Bus 连接线（0.8 m）不可混用，否则可能损坏设备。
- 连接 Inspire 2 遥控器时，确保使用标配 Inspire 2 RC CAN Bus 连接线连接至主遥控器，不可使用无线接收机。

内容如有更新，恕不另行通知。

您可以在 DJI 官方网站查询最新版本《使用说明》
<https://www.dji.com/force-pro>

RONIN 是大疆灵眸的商标。

Copyright © 2019 大疆灵眸 版权所有

Compliance Information

FCC Compliance Notice

This device complies with Part 15 of the FCC Rules. Operation is subject to the following two conditions: (1) This device may not cause harmful interference, and (2) This device must accept any interference received, including interference that may cause undesired operation.

Any changes or modifications not expressly approved by the party responsible for compliance could void the user's authority to operate the equipment.

This equipment has been tested and found to comply with the limits for a Class B digital device, pursuant to part 15 of the FCC Rules. These limits are designed to provide reasonable protection against harmful interference in a residential installation. This equipment generates, uses and can radiate radio frequency energy and, if not installed and used in accordance with the instructions, may cause harmful interference to radio communications. However, there is no guarantee that interference will not occur in a particular installation. If this equipment does cause harmful interference to radio or television reception, which can be determined by turning the equipment off and on, the user is encouraged to try to correct the interference by one or more of the following measures:

- Reorient or relocate the receiving antenna.
- Increase the separation between the equipment and receiver.
- Connect the equipment into an outlet on a circuit different from that to which the receiver is connected.
- Consult the dealer or an experienced radio/TV technician for help.

RF Exposure Information

This equipment complies with FCC radiation exposure limits set forth for an uncontrolled environment. In order to avoid the possibility of exceeding the FCC radio frequency exposure limits, this transmitter must not be co-located or operating in conjunction with any other antenna or transmitter.

IC RSS Warning

This device complies with Industry Canada licence-exempt RSS standard (s). Operation is subject to the following two conditions: (1) this device may not cause interference, and (2) this device must accept any interference, including interference that may cause undesired operation of the device.

Le présent appareil est conforme aux CNR d'Industrie Canada applicables aux appareils radio exempts de licence.

L'exploitation est autorisée aux deux conditions suivantes:

- (1) l'appareil ne doit pas produire de brouillage, et
- (2) l'utilisateur de l'appareil doit accepter tout brouillage radioélectrique subi, même si le brouillage est susceptible d'en compromettre le fonctionnement.

IC Radiation Exposure Statement:

This equipment complies with IC RF radiation exposure limits set forth for an uncontrolled environment. This transmitter must not be co-located or operating in conjunction with any other antenna or transmitter.

Any Changes or modifications not expressly approved by the party responsible for compliance could void the user's authority to operate the equipment.

KCC Warning Message

"해당무선설비는 운용 중 전파혼신 가능성이 있으므로 인명안전과 관련된 서비스는 할 수 없습니다."
"해당 무선설비는 운용 중 전파혼신 가능성이 있음"

NCC Warning Message

低功率電波輻射性電機管理辦法

第十二條 經型式認證合格之低功率射頻電機，非經許可，公司、商號或使用者均不得擅自變更頻率、加大功率或變更原設計之特性及功能。

第十四條 低功率射頻電機之使用不得影響飛航安全及干擾合法通信；經發現有干擾現象時，應改善至無干擾時方得繼續使用。前項合法通信，指依電信法規定作業之無線電通信。低功率射頻電機須忍受合法通信或工業、科學及醫療用電波輻射性電機設備之干擾。

EU Compliance Statement: SZ DJI Osmo Technology Co., Ltd. hereby declares that this device is in compliance with the essential requirements and other relevant provisions of the Directive 2014/53/EU.

A copy of the EU Declaration of Conformity is available online at www.dji.com/euro-compliance

EU contact address: DJI GmbH, Industriestrasse 12, 97618, Niederlauer, Germany

Declaración de cumplimiento UE: SZ DJI Osmo Technology Co., Ltd. por la presente declara que este dispositivo cumple los requisitos básicos y el resto de provisiones relevantes de la Directiva 2014/53/EU.

Hay disponible online una copia de la Declaración de conformidad UE en www.dji.com/euro-compliance

Dirección de contacto de la UE: DJI GmbH, Industriestrasse 12, 97618, Niederlauer, Germany

EU-verklaring van overeenstemming: SZ DJI Osmo Technology Co., Ltd. verklaart hierbij dat dit apparaat voldoet aan de essentiële vereisten en andere relevante bepalingen van Richtlijn 2014/53/EU.

De EU-verklaring van overeenstemming is online beschikbaar op www.dji.com/euro-compliance

Contactadres EU: DJI GmbH, Industriestrasse 12, 97618, Niederlauer, Germany

Declaração de conformidade da UE: A SZ DJI Osmo Technology Co., Ltd. declara, através deste documento, que este dispositivo está em conformidade com os requisitos essenciais e outras disposições relevantes da Diretiva 2014/53/EU.

Existe uma cópia da Declaração de conformidade da UE disponível online em www.dji.com/euro-compliance

Endereço de contacto na UE: DJI GmbH, Industriestrasse 12, 97618, Niederlauer, Germany

Dichiarazione di conformità UE: SZ DJI Osmo Technology Co., Ltd. dichiara che il presente dispositivo è conforme ai requisiti essenziali e alle altre disposizioni rilevanti della direttiva 2014/53/EU.

Una copia della dichiarazione di conformità UE è disponibile online all'indirizzo Web www.dji.com/euro-compliance

Indirizzo di contatto UE: DJI GmbH, Industriestrasse 12, 97618, Niederlauer, Germany

Déclaration de conformité UE : Par la présente, SZ DJI Osmo Technology Co., Ltd. déclare que cet appareil est conforme aux principales exigences et autres clauses pertinentes de la directive européenne 2014/53/EU.

Une copie de la déclaration de conformité UE est disponible sur le site www.dji.com/euro-compliance

Adresse de contact pour l'UE : DJI GmbH, Industriestrasse 12, 97618, Niederlauer, Germany

EU-Compliance: Hiermit erklärt SZ DJI Osmo Technology Co., Ltd., dass dieses Gerät den wesentlichen Anforderungen und anderen einschlägigen Bestimmungen der EU-Richtlinie 2014/53/EU entspricht.

Eine Kopie der EU-Konformitätserklärung finden Sie online auf www.dji.com/euro-compliance.

Kontaktadresse innerhalb der EU: DJI GmbH, Industriestrasse 12, 97618, Niederlauer, Germany



CAUTION: RISK OF EXPLOSION IF BATTERY IS REPLACED BY AN INCORRECT TYPE.
DISPOSE OF USED BATTERIES ACCORDING TO THE INSTRUCTIONS

Environmentally friendly disposal



Old electrical appliances must not be disposed of together with the residual waste, but have to be disposed of separately. The disposal at the communal collecting point via private persons is for free. The owner of old appliances is responsible to bring the appliances to these collecting points or to similar collection points. With this little personal effort, you contribute to recycle valuable raw materials and the treatment of toxic substances.

Thailand Warning message

เครื่องโทรคมนาคมและอุปกรณ์นี้ มีความปลอดภัยตามกฎหมายของ กทช.

Mexico Warning message

"La operación de este equipo está sujeta a las siguientes dos condiciones: (1) es posible que este equipo o dispositivo no cause interferencia perjudicial y (2) este equipo o dispositivo debe aceptar cualquier interferencia, incluyendo la que pueda causar su operación no deseada."

Brazil Warning message

Este equipamento opera em caráter secundário, isto é, não tem direito a proteção contra interferência prejudicial, mesmo de estações do mesmo tipo, e não pode causar interferência a sistemas operando em caráter primário

部件名称	有害物质					
	铅 (Pb)	汞 (Hg)	镉 (Cd)	六价铬 (Cr ⁶⁺)	多溴联苯 (PBB)	多溴二苯醚 (PBDE)
线路板	x	○	○	○	○	○
外壳	x	○	○	○	○	○
金属部件 (铜合金)	x	○	○	○	○	○
内部线材	x	○	○	○	○	○
其他配件	x	○	○	○	○	○

本表格依据 SJ/T 11364 的规定编制。
 ○：表示该有害物质在该部件所有均质材料中的含量均在 GB/T 26572 规定的限量要求以下。
 x：表示该有害物质至少在该部件的某一均质材料中的含量超出 GB/T 26572 规定的限量要求。（产品符合欧盟 ROHS 指令环保要求）

DJI Support
DJI 技术支持

<http://www.dji.com/support>

If you have any questions about this document,
please contact DJI by sending a message to
DocSupport@dji.com.

如果您对说明书有任何疑问或建议，请通过以下
电子邮箱联系我们：**DocSupport@dji.com**。

Printed in China.
中国印制

保密文件，授权接触，违者追责

物料编码	用料	工艺	装订	P数	尺寸	受控日期	设计师
YC.BZ.SS000625.02	道林纸: 封面 100g 内文 80g	单黑印刷	胶装	124	75*158 mm	2019.4.17	10014785
变更内容	中英升级为多语言						

收货标准（包括但不限于）

1. 内容按图纸，文件名料号、封底料号、标签料号需全部一致
2. 包材干净无损不受潮
3. 印刷清晰、颜色均匀、无重影
4. 裁切尺寸准确，不能裁切到文字
5. 装订页码顺序正确，无错页、无漏页、无倒页，表面平整无折皱，折页整齐无爆边
6. 骑钉说明书尺寸小于等于 80mm 订一颗钉，骑钉无损且保证至少一年内不生锈
7. 胶装装订整齐不开胶，不漏胶，胶水环保无异味

此页非印刷页 印刷前请删除

封面水印 confidential，印刷前请删除